

ARTEK

DURAVAR[®] UHMW-PE ULTRA-HIGH MOLECULAR WEIGHT POLYETHYLENE

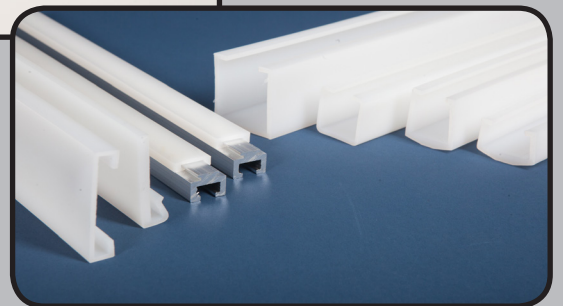

INDUSTRIAL MARKET PROFILES SHAPES
PRODUCT GUIDE

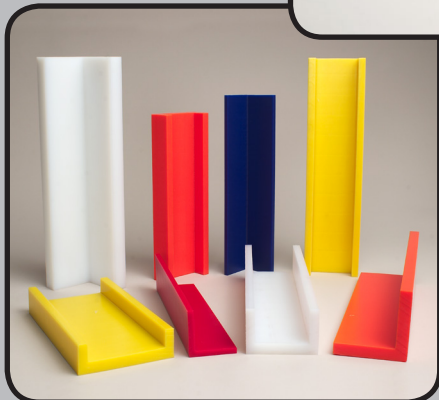
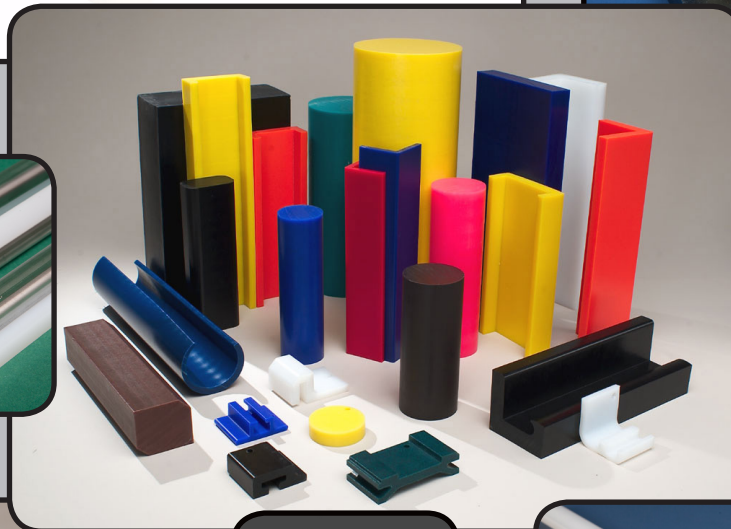
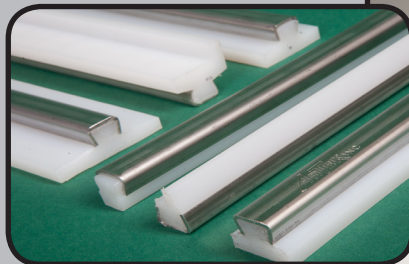
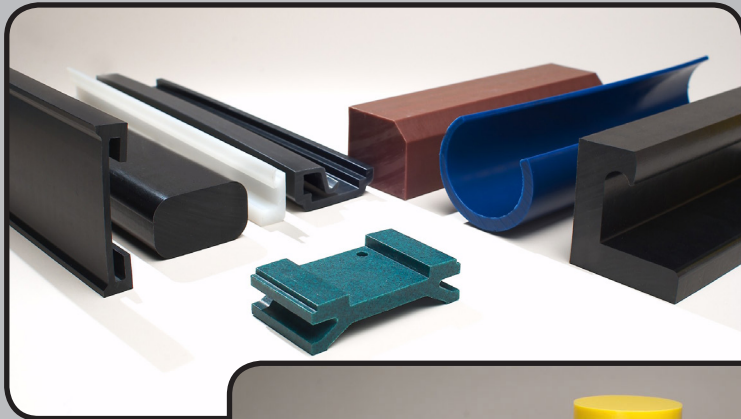

WELCOME TO ARTEK

Manufacturer of Duravar® Ultra-High Molecular Weight Polyethylene



ARTEK OPTIONS & SERVICES

Virgin & Reprocessed Color:

Standard Color for most Virgin products is natural. Virgin and Reprocessed materials are both available in selected colors. A wide variety of Special Colors and FDA Colors are also available to meet your application requirements.

Optional Product Lengths:

Most items such as Angle, Channel, Chain Guide and Guide Rail are available from inventory in standard 10 foot lengths. While some Standard Profile Shapes may also be available in 100 foot coils. Most of Artek's shapes can be extruded to any desired length on a special order basis.

Duravar® Formulations:

Artek has the capability to produce and provide modified or enhanced formulations to improve application performance. Some of these enhancements include UV-Stabilization, Static Reduction, Improved Coefficient of Friction, and Increased Abrasion Resistance.

Custom Profiles:

Artek's specialized capabilities include the production and design of custom proprietary profile dies. Artek's engineering staff is available to provide technical assistance, service and support in designing a special profile related to cost efficient tooling and production.

Artek is continually adding new extruded UHMW-PE Profile shapes to our product line.
If the custom or standard profile you need does not appear here, please give our sales team a call.



WELCOME TO ARTEK

Manufacturer of Duravar® Ultra-High Molecular Weight Polyethylene

Artek Duravar® UHMW-PE Product Table of Contents

Duravar®	2
Duravar® Table of Contents	3
Duravar® Angle & Channel Profiles	4
Duravar® Standard Profile Shapes	5
Duravar® Standard Profile Shapes.....	6
Duravar® Standard Profile Shapes.....	7
Duravar® Chain Guide Profiles	8
Duravar® Roller Chain Profiles	9
Duravar® Roller Chain Profiles	10
Duravar® V & Roller Belt Profiles.....	11
Duravar® Guide Rail Profiles	12
Duravar® Guide Rail Accessories.....	13
Duravar® Waste Water Wear Strips.....	14
Duravar® Waste Water Wear Shoes	15

Commitment To Quality, Support and Service

Artek Inc., a manufacturer of Ultra-High Molecular Weight Polyethylene was incorporated in 1985 with a purpose to produce and sell a quality, high performance polymer called Duravar UHMW-PE. Artek continuously strives to satisfy the customer needs, and is committed to meeting their daily challenges by providing dependable quality, reliable support and faithful service.

Thank You for being a part of the “Artek Team”



DURAVAR®

Angle & Channel Profile

Ultra-High Molecular Weight Polyethylene

ANGLE PROFILE

PRODUCT CODE	"A" DIM.	"B" DIM.	"C" DIM.	WEIGHT LBS./FT.
AG-405	1/8"	1"	1"	.103
AG-410	1/4"	5/8"	1-1/2"	.193
AG-415	1/4"	1"	1"	.205
AG-417	1/4"	1-1/4"	1-1/4"	.256
AG-420	1/4"	1-1/2"	1-1/2"	.300
AG-425	1/4"	2"	2"	.410
AG-440	3/8"	1"	1"	.254
AG-442	3/8"	1-1/2"	1-1/2"	.410
AG-444	3/8"	2"	2"	.567
AG-446	3/8"	2-1/2"	2-1/2"	.723
AG-447	3/8"	2"	3"	.723
AG-449	3/8"	3"	3"	.879
AG-426	1/2"	1-1/2"	1-1/2"	.621
AG-427	1/2"	2"	2"	.827
AG-428	1/2"	2"	6"	1.550
AG-430	1/2"	3"	3"	1.190
AG-431	1/2"	3-1/2"	3-1/2"	1.390
AG-435	3/4"	3"	3"	1.790

CHANNEL PROFILE

PRODUCT CODE	"A" DIM.	"B" DIM.	"C" DIM.	"D" DIM.	WEIGHT LBS./FT.
CH-461	1/2"	7/8"	1-7/16"	1-15/16"	.41
CH-462	5/8"	1"	2"	2-1/2"	.52
CH-460	3/4"	1"	3"	3-1/2"	.52
CH-465	3/4"	1"	3-1/2"	4"	.58
CH-470	3/4"	1-1/4"	2-1/8"	3"	.92
CH-446	3/4"	1-1/4"	2-5/8"	3-1/2"	1.00
CH-475	3/4"	1-1/4"	2-1/2"	3"	.78
CH-480	3/4"	1-1/4"	3-1/4"	4"	1.07
CH-473	3/4"	1-1/4"	2-1/4"	3"	.86
CH-472	13/16"	1-3/16"	1-9/16"	2"	.94
CH-474	1-1/2"	2"	2-1/4"	3"	1.04

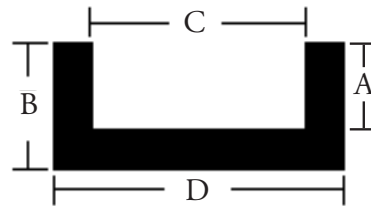
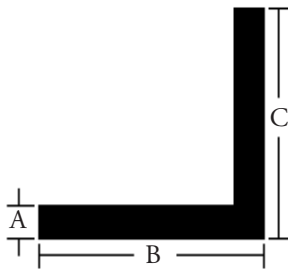

Formulations: Virgin Natural, Virgin Color, Reprocessed Blends & Enhanced Formulations

Colors: All Standard Colors Meet FDA Requirements.
Custom Color Matching Available

Lengths: Standard = 120" Lengths - Custom = Available upon special request

Industry Standard Profile Shapes

Ultra-High Molecular Weight Polyethylene

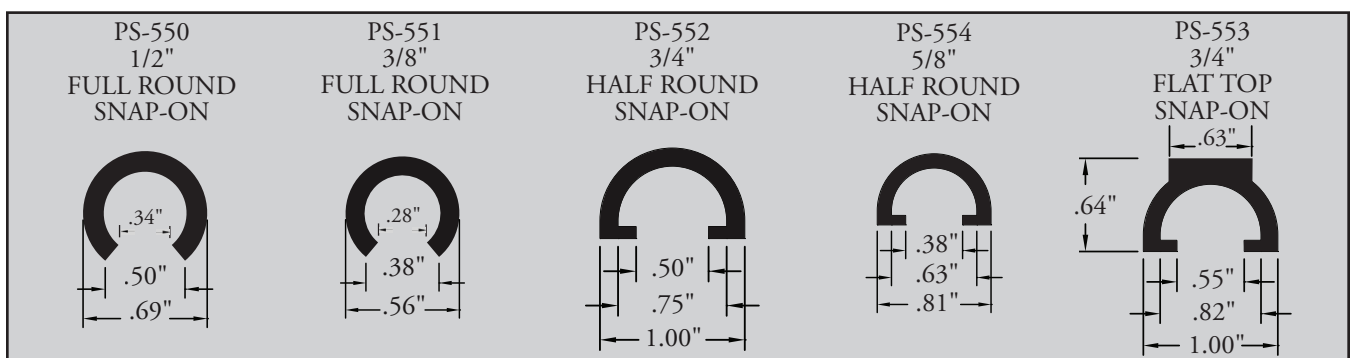
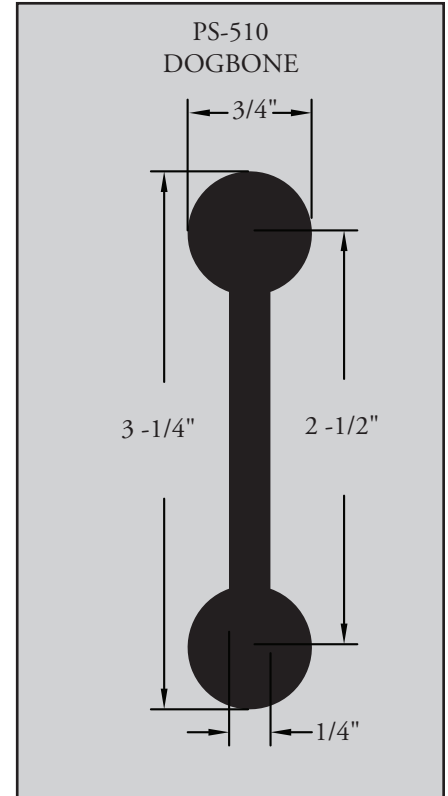
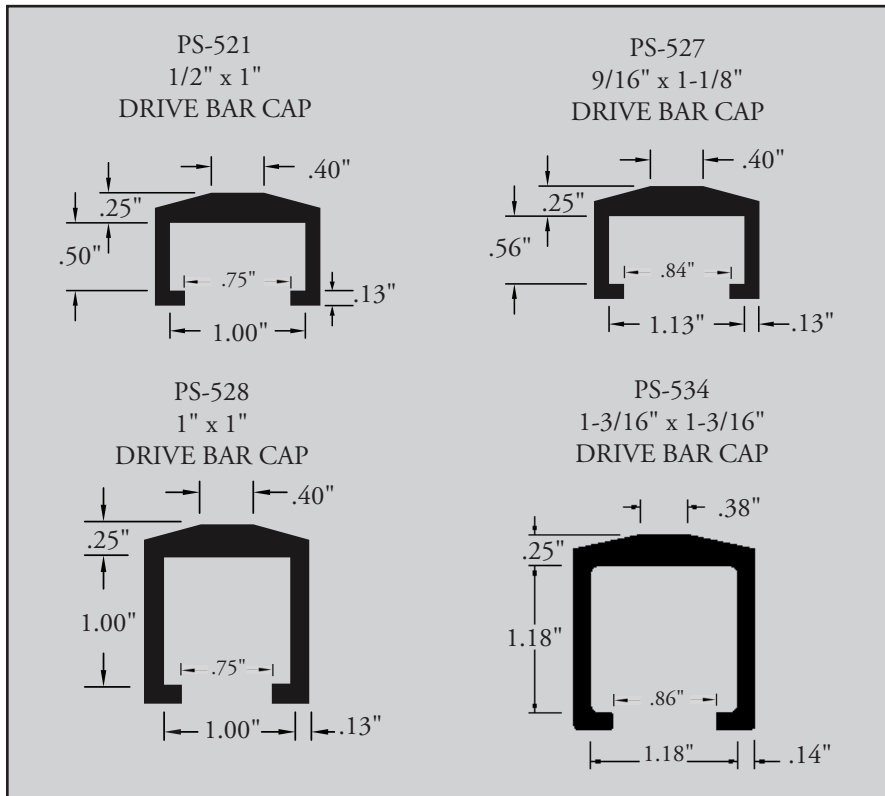
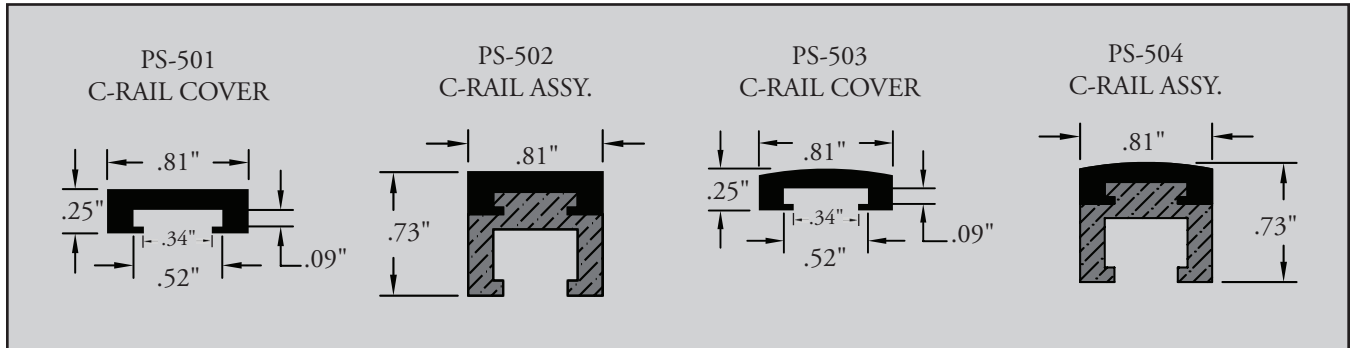

Industry Standard Profile Shapes

Ultra-High Molecular Weight Polyethylene

PS-561
BAR CLIP-ON

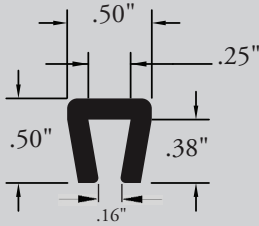

PS-562
BAR CLIP-ON

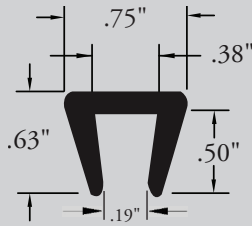

PS-568
BAR CLIP-ON

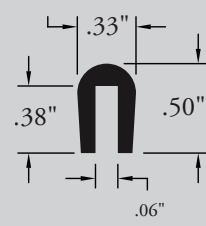

PS-566
3/4\" BAR-CLIP

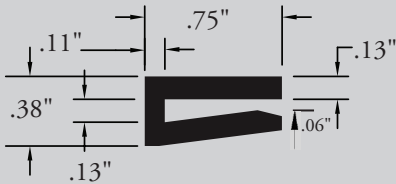

PS-567
1\" BAR-CLIP

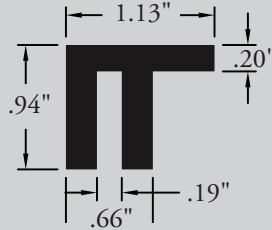

PS-565
3/16\" BAR CLIP

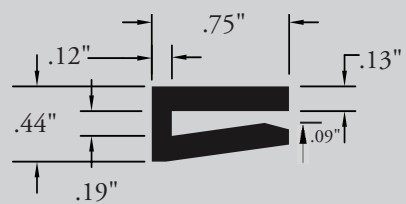

PS-540
.75\" J-LEG

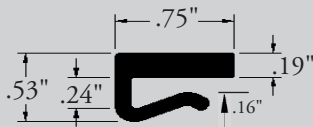

PS-541
1\" J-LEG

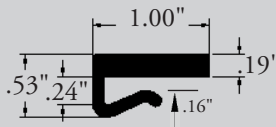

PS-542
1.5\" J-LEG

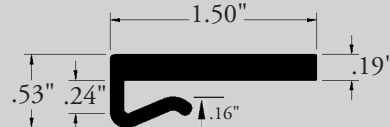

PS-544
2\" J-LEG

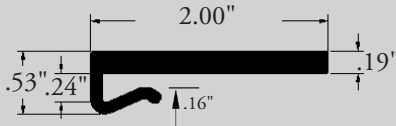

PS-546
2.5\" J-LEG

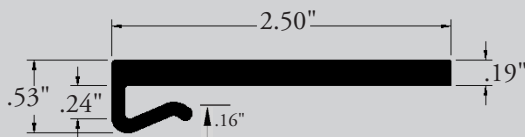

PS-549
3\" J-LEG

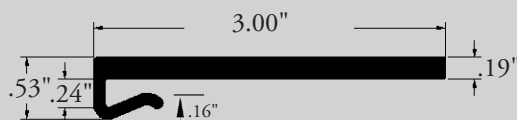

Industry Standard Profile Shapes

Ultra-High Molecular Weight Polyethylene

PS-569
3/8" x 1-1/4"
GUIDE RAIL SNAP-ON

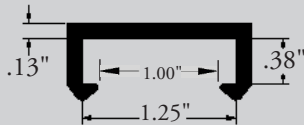

PS-520
1/4" x 2"
GUIDE RAIL SNAP-ON

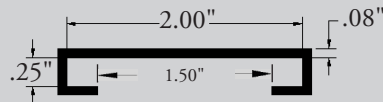

PS-522
1/4" x 1"
GUIDE RAIL SNAP-ON

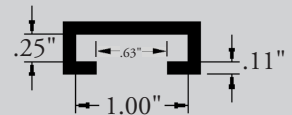

PS-523
1-1/2" x 1-1/2"
GUIDE RAIL SNAP-ON

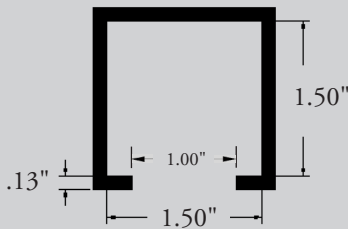

PS-524
1" x 1"
GUIDE RAIL SNAP-ON

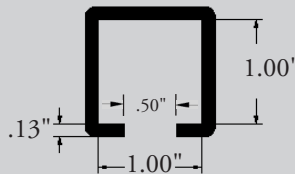

PS-525
1/2" x 1-1/2"
GUIDE RAIL SNAP-ON

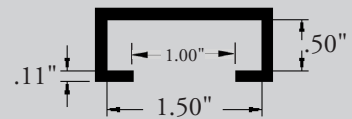

PS-526
1-1/2" x 2"
GUIDE RAIL SNAP-ON

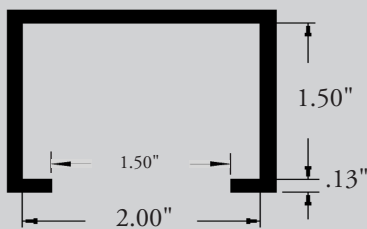

PS-529
1/2" x 2"
GUIDE RAIL SNAP-ON

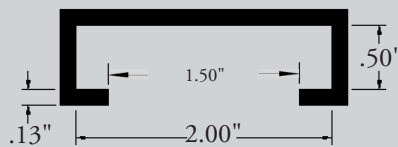

PS-530
1-1/4" x 1-1/4"
GUIDE RAIL SNAP-ON

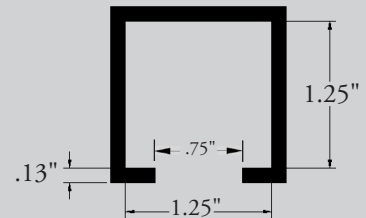

PS-531
1" x 2"
GUIDE RAIL SNAP-ON

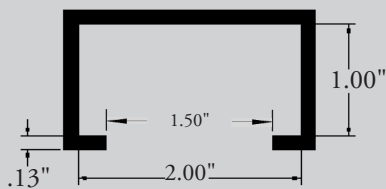

PS-532
2" x 2"
GUIDE RAIL SNAP-ON

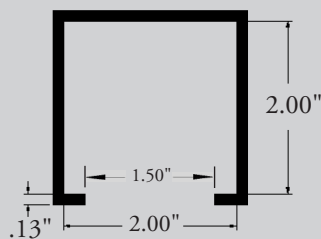

PS-533
1/4" x 1-1/2"
GUIDE RAIL SNAP-ON

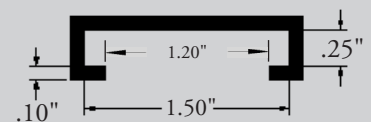



DURAVAR®

Chain Guide Profile

Ultra-High Molecular Weight Polyethylene

CHAIN GUIDE CONFIGURATION	PRODUCT CODE	ANSI CHAIN NO.	MIN. T	MIN. W	H	P	S	Y	
Profile – CG1 	CG1-2040	2040	5/16	1-1/4	1/8	-	7/8	-	
	CG1-2050	2050	3/8	1-1/4	5/32	-	1	-	
	CG1-2060	2060	3/8	1-1/2	3/16	-	1-1/4	-	
	CG1-2080	2080	1/2	2	1/4	-	1-9/16	-	
	CG1-2100	2100	5/8	2-1/4	5/16	-	1-7/8	-	
	CG1-2120	2120	2120	5/8	2-3/4	3/8	-	2-1/4	-
Profile – CG2 	CG2-2040	2040	5/16	1-1/4	1/8	-	7/8	-	
	CG2-2050	2050	3/8	1-1/4	5/32	-	1	-	
	CG2-2060	2060	3/8	1-1/2	3/16	-	1-1/4	-	
	CG2-2080	2080	2080	1/2	2	1/4	-	1-9/16	-
	CG2-2100	2100	2100	5/8	2-1/4	5/16	-	1-7/8	-
	CG2-2120	2120	2120	5/8	2-3/4	3/8	-	2-1/4	-
Profile—CG3 	CG3-2040	2040	1/2	1	1/4	-	3/4	-	
	CG3-2050	2050	1/2	1-1/4	9/32	-	1	-	
	CG3-2060	2060	5/8	1-1/2	5/16	-	1-1/4	-	
	CG3-2080	2080	2080	5/8	2	3/8	-	1-1/2	-
	CG3-2100	2100	2100	3/4	2-1/4	7/16	-	1-13/16	-
	CG3-2120	2120	2120	7/8	3	9/16	-	2-1/4	-
Profile—CG4 	CG4-2040	2040	1/2	1	1/4	-	3/4	-	
	CG4-2050	2050	1/2	1-1/4	9/32	-	1	-	
	CG4-2060	2060	5/8	1-1/2	5/16	-	1-1/4	-	
	CG4-2080	2080	2080	5/8	2	3/8	-	1-1/2	-
	CG4-2100	2100	2100	3/4	2-1/4	7/16	-	1-13/16	-
	CG4-2120	2120	2120	7/8	3	9/16	-	2-1/4	-
Profile – CG5 	CG5-2040	2040	5/16	1	.080	-	-	1/4	
	CG5-2050	2050	5/16	1-1/4	.100	-	-	5/16	
	CG5-2060	2060	5/16	1-1/4	.115	-	-	7/16	
	CG5-2080	2080	2080	3/8	1-1/2	.130	-	9/16	
	CG5-2100	2100	2100	1/2	2	.210	-	11/16	
	CG5-2120	2120	2120	1/2	2-1/4	.260	-	15/16	
Profile – CG6 	CG6-2040	2040	5/16	1	.080	-	-	1/4	
	CG6-2050	2050	5/16	1-1/4	.100	-	-	5/16	
	CG6-2060	2060	5/16	1-1/4	.115	-	-	7/16	
	CG6-2080	2080	2080	3/8	1-1/2	.130	-	9/16	
	CG6-2100	2100	2100	1/2	2	.210	-	11/16	
	CG6-2120	2120	2120	1/2	2-1/4	.260	-	15/16	
Profile – CG7 	CG7-2040	2040	5/16	1	.140	.080	11/16	1/4	
	CG7-2050	2050	3/8	1-1/4	3/16	.100	13/16	5/16	
	CG7-2060	2060	1/2	1-1/2	.213	.115	1-1/8	7/16	
	CG7-2080	2080	1/2	2	1/4	.130	1-7/16	9/16	



DURAVAR® Roller Chain Profile

Ultra-High Molecular Weight Polyethylene

Roller Chain Profile Specification Page #1 of 2

TYPE "T" PROFILE	PRODUCT CODE	ANSI		B	T	W			t
	CG8-2825	25	-	.78	.59	.10	-	-	.09
	CG8-2835	35	-	.78	.59	.17	-	-	.10
	CG8-2840	40	-	.78	.59	.29	-	-	.10
	CG8-2850	50	-	.78	.59	.35	-	-	.12
	CG8-2860	60	-	1.10	.59	.47	-	-	.15
	CG8-2880	80	-	1.34	.71	.60	-	-	.18
	CG8-2810	100	-	1.61	1.00	.72	-	-	.26
	CG8-2812	120	-	2.01	1.25	.96	-	-	.31
	CG8-2814	140	-	2.17	1.50	.96	-	-	.36
	CG8-2816	160	-	2.61	1.50	1.21	-	-	.42
CG8-2818	180	-	2.88	1.50	1.35	-	-	.47	

TYPE "TD" PROFILE	PRODUCT CODE	ANSI		B	T	W	t	E	Fig
	(Figure-A)								
	CG9-2925	25-2	-	.78	.59	.10	.09	.15	A
	CG9-2935	35-2	-	.78	.59	.17	.10	.23	A
	(Figure-B)								
	CG9-2940	40-2	-	.85	.59	.29	.10	.27	B
	CG9-2950	50-2	-	1.07	.59	.35	.12	.37	B
	CG9-2960	60-2	-	1.34	.59	.47	.15	.40	B
CG9-2980	80-2	-	1.75	.71	.60	.18	.55	B	

TYPE "U" PROFILE	PRODUCT CODE	ANSI		B	T	T2	T3	D2	H
	CG10-3025	25	-	.78	.59	.09	.13	.12	.27
	CG10-3035	35	-	.78	.59	.15	.22	.16	.39
	CG10-3040	40	-	.78	.59	.18	.26	.21	.51
	CG10-3050	50	-	1.10	.71	.24	.35	.28	.67
	CG10-3060	60	-	1.10	.71	.28	.41	.32	.78
	CG10-3080	80	-	1.50	.79	.30	.47	.43	1.04

TYPE "K" PROFILE	PRODUCT CODE	ANSI	B	T	W	T2	T3	D1	H
	CG11-3125	25	.78	.88	.10	.20	.24	.15	.27
	CG11-3135	35	.78	.88	.17	.32	.40	.22	.39
	CG11-3140	40	1.10	1.05	.29	.45	.52	.33	.51
	CG11-3150	50	1.50	1.43	.35	.55	.61	.42	.67
	CG11-3160	60	1.50	1.85	.47	.76	.88	.49	.78
	CG11-3180	80	1.50	2.45	.60	.96	1.19	.65	1.04



DURAVAR®

Roller Chain Profile

Ultra-High Molecular Weight Polyethylene

Roller Chain Profile Specification Page #2 of 2

TYPE "CF" PROFILE	PRODUCT CODE		Chl		T	Tc	B		t
	CG12-3201	-	C-3	-	.59	.79	.78	-	.40
	CG12-3202	-	C-5	-	.79	1.03	1.10	-	.56
	CG12-3203	-	C-9	-	.79	1.16	1.50	-	.45
	CG12-3204	-	C-5	-	.39	.63	1.10	-	.16

TYPE "CT" PROFILE	PRODUCT CODE	ANSI	Chl		T	Tc	B	W	t
	CG13-3325	25	C3	-	.59	.79	.78	.10	.09
	CG13-3335	35	C3	-	.59	.79	.78	.17	.10
	CG13-3340	40	C3	-	.59	.79	.78	.29	.10
	CG13-3350	50	C3	-	.59	.79	.78	.35	.12
	CG13-3360	60	C5	-	.59	.79	1.10	.46	.15
	CG13-3380	80	C5	-	.71	.95	1.34	.60	.18

TYPE "CTD" PROFILE	PRODUCT CODE	ANSI	Chl	T	Tc	B	W	t	E
	(Figure-A)								
	CG14-3425	25-2	C3	.59	.79	.78	.10	.09	.15
	CG14-3435	35-2	C3	.59	.79	.78	.17	.10	.23
	(Figure-B)								
	CG14-3440	40-2	C3	.59	.79	.85	.29	.10	-
	CG14-3450	50-2	C5	.59	.79	1.06	.35	.12	-
	CG14-3460	60-2	C5	.59	.79	1.34	.47	.15	-
	CG14-3480	80-2	C9	.71	.95	1.75	.60	.18	-

TYPE "CU" PROFILE	PRODUCT CODE	ANSI	Chl		T	Tc	B	H	S
	CG15-3525	25	C3	-	.59	.79	.78	.27	.09
	CG15-3535	35	C3	-	.59	.79	.78	.39	.15
	CG15-3540	40	C3	-	.59	.79	.78	.51	.18
	CG15-3550	50	C5	-	.71	.95	1.10	.67	.24
	CG15-3560	60	C5	-	.71	.95	1.10	.78	.28
	CG15-3580	80	C9	-	.79	1.16	1.50	1.04	.30

TYPE "CK" PROFILE	PRODUCT CODE	ANSI	Chl		Tc	B	W		d1
	CG16-3625	25	C3	-	.94	.78	.10	-	.15
	CG16-3635	35	C3	-	.94	.78	.17	-	.22
	CG16-3640	40	C5	-	1.13	1.10	.29	-	.33
	CG16-3650	50	C9	-	1.53	1.50	.35	-	.42
	CG16-3660	60	C9	-	1.95	1.50	.47	-	.49
	CG16-3680	80	C9	-	2.55	1.50	.60	-	.65

TYPE "CKG" PROFILE	PRODUCT CODE	ANSI	Chl	Tc	Tc1	B	W	W1	d1
	CG17-3725	25	C9	.71	-	1.50	.10	-	.15
	CG17-3735	35	C10	.94	-	1.18	.17	-	.22
	CG17-3740	40	C10	.94	-	1.18	.29	-	.33
	CG17-3750	50	C10	.94	-	1.18	.35	-	.42
	CG17-3760	60	C10	-	1.02	1.18	-	.47	.49
	CG17-3761	60	C11	1.58	-	1.77	.47	-	.49
	CG17-3780	80	C11	1.58	-	1.77	.60	-	.65

STAINLESS STEEL OR GALVANIZED STEEL CHANNELS AVAILABLE UPON REQUEST



DURAVAR® V & Roller Belt Profile

Ultra-High Molecular Weight Polyethylene

DURAVAR® “V” BELT PROFILES

TYPE “V” PROFILE	PRODUCT CODE	Belt		T	B			D	H
	CG18-BG2208	M	-	.38	.75	-	-	.25	.13
	CG18-BG2210	Z	-	.38	.75	-	-	.28	.19
	CG18-BG2213	A	-	.50	.75	-	-	.38	.25
	CG18-BG2217	B	-	.63	1.25	-	-	.47	.31
	CG18-BG2220	-	-	.75	1.25	-	-	.53	.38
	CG18-BG2222	C	-	.75	1.38	-	-	.56	.44
	CG18-BG2225	-	-	1.00	1.50	-	-	.66	.50

TYPE “CV” PROFILE	PRODUCT CODE	Belt	Chl	T	B	C	Tc	D	H
	CG19-BG1425	M	C3	.59	.78	.10	.79	.25	.13
	CG19-BG1428	Z	C3	.59	.78	.10	.79	.28	.19
	CG19-BG1438	A	C3	.59	.78	.12	.79	.38	.25
	CG19-BG1447	B	C5	.59	1.10	.12	.79	.47	.31
	CG19-BG1453	-	C5	.81	1.10	.12	1.04	.53	.38
	CG19-BG1456	C	C5	.81	1.10	.14	1.04	.56	.44
	CG19-BG1466	-	C9	1.00	1.50	.14	1.38	.66	.50

DURAVAR® “ROUND” BELT PROFILES

TYPE “R” PROFILE	PRODUCT CODE	Belt		T	B			D	H
	CG20-BG2005	3/16	-	.38	.75	-	-	.25	.13
	CG20-BG2006	1/4	-	.38	.75	-	-	.31	.16
	CG20-BG2008	5/16	-	.50	.75	-	-	.38	.19
	CG20-BG2010	3/8	-	.63	1.00	-	-	.44	.22
	CG20-BG2012	1/2	-	.75	1.25	-	-	.56	.28
	CG20-BG2015	5/8	-	1.00	1.25	-	-	.69	.35
	CG20-BG2018	3/4	-	1.00	1.50	-	-	.81	.41











TYPE “CR” PROFILE	PRODUCT CODE	Belt	Chl	T	B	C	Tc	D	H
	CG21 -BG1125	3/16	C3	.59	.78	.10	.79	.25	.13
	CG21 -BG1131	1/4	C3	.59	.78	.10	.79	.31	.16
	CG21 -BG1138	5/16	C3	.59	.78	.12	.79	.38	.19
	CG21 -BG1144	3/8	C5	.59	1.10	.12	.79	.44	.22
	CG21 -BG1156	1/2	C5	.59	1.10	.12	.79	.56	.28
	CG21 -BG1169	5/8	C5	.75	1.10	.12	.94	.69	.35
	CG21 -BG1181	3/4	C5	1.00	1.10	.12	1.25	.81	.41

STAINLESS STEEL OR GALVANIZED STEEL CHANNELS AVAILABLE UPON REQUEST



DURAVAR[®] Guide Rail Profile

Ultra-High Molecular Weight Polyethylene

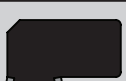
GUIDE RAIL DESIGN	DESCRIPTION CONFIGURATION	PRODUCT CODE	WEIGHT LBS./FT.	FORMULATIONS MATERIAL OPTIONS
	Round	GR-045R-10 GR-045R-20	.47	Virgin Natural Black Static Reduced Enhanced
	Convex	GR-045C-10 GR-045C-20	.46	Virgin Natural Black Static Reduced Enhanced
	Flat .453"	GR-045F-10 GR-045F-20	.46	Virgin Natural Black Static Reduced Enhanced
	Neck Guide	GR-045NG-10 GR-045NG-20	.45	Virgin Natural Black Static Reduced Enhanced
	Flat 3/4"	GR-075F-10 GR-075F-20	.50	Virgin Natural Black Static Reduced Enhanced
	Flat 1"	GR-100F-10 GR-100F-20	.52	Virgin Natural Black Static Reduced Enhanced
	Tee 1"	GR-100T-10 GR-100T-20	.58	Virgin Natural Black Static Reduced Enhanced
	Tee 1-1/4"	GR-125T-10 GR-125T-20	.60	Virgin Natural Black Static Reduced Enhanced
	Tee 1.6"	GR-160T-10 GR-160T-20	.64	Virgin Natural Black Static Reduced Enhanced
	Tee 2-1/4"	GR-225T-10 GR-225T-20	.74	Virgin Natural Black Static Reduced Enhanced
	Edge Guide	GR-125EG-10 GR-125EG-20	.64	Virgin Natural Black Static Reduced Enhanced
	Tab Guide	GR-190TG-10 GR-190TG-20	.72	Virgin Natural Black Static Reduced Enhanced

Guide Rail is also available in 5, 8, and 12 ft. lengths, with custom lengths available upon special request.



DURAVAR®

Guide Rail Accessories

Splicing Sheaths, Splicing Clamps & Rail Clips

Guide Rail Splicing Sheaths (14 Gauge - Stainless Steel)

	ITEM #	PRODUCT CODE	LENGTH (IN.)	
	A	RA-013-04	4"	—
	B	RA-013-03	3"	—
	C	RA-013-02	2"	—

Guide Rail Splicing Clamps (11 Gauge - Stainless Steel)

	ITEM #	PRODUCT CODE	RAIL CENTER (IN.)	FASTENER SIZE
	A	RA-012-01	Single	3/8"
	B	RA-011-01	2-1/2"	3/8"
	C	RA-011-03	3-3/4"	3/8"

Guide Rail Clips (Aluminum, Plastic Compression & Stainless Steel)

	ITEM #	PRODUCT CODE	BOLT (IN.)	THREAD (IN.)
	A	RA-018-02	3/4"	5/16"
	B	RA-016-02	3/4"	5/16"

The above accessories are to be purchased in conjunction with Duravar Guide Rail Profiles.

DURAVAR®

Waste Water Treatment Wearstrips

Ultra-High Molecular Weight Polyethylene

Duravar® Starter Wear Strips

PRODUCT CODE	THICKNESS (IN.)	WIDTH (IN.)	LENGTH (IN.)	CENTER LINE
WW-SWS0005	3/8"	2-5/8"	120"	1-15/16"
WW-SWS0010	3/8"	3"	120"	1-1/2"
WW-SWS0015	1/2"	2-1/2"	120"	1-1/4"
WW-SWS0020	1/2"	3"	120"	1-1/2"
WW-SWS0022	1/2"	3-1/2"	120"	1-3/4"
WW-SWS0025	1/2"	4"	120"	2"
WW-SWS0030	1/2"	5"	120"	2-1/2"
WW-SWS0035	5/8"	2-1/2"	120"	1-1/4"
WW-SWS0040	5/8"	3"	120"	1-1/2"
WW-SWS0045	5/8"	4"	120"	2"
WW-SWS0050	5/8"	5"	120"	2-1/2"

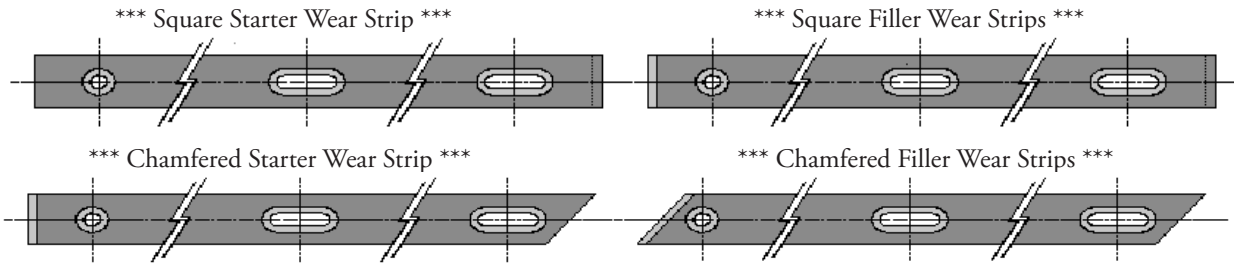

Duravar® Filler Wear Strips

PRODUCT CODE	THICKNESS (IN.)	WIDTH (IN.)	LENGTH (IN.)	CENTER LINE
WW-FWS0005	3/8"	2-5/8"	120"	1-15/16"
WW-FWS0010	3/8"	3"	120"	1-1/2"
WW-FWS0015	1/2"	2-1/2"	120"	1-1/4"
WW-FWS0020	1/2"	3"	120"	1-1/2"
WW-FWS0022	1/2"	3-1/2"	120"	1-3/4"
WW-FWS0025	1/2"	4"	120"	2"
WW-FWS0030	1/2"	5"	120"	2-1/2"
WW-FWS0035	5/8"	2-1/2"	120"	1-1/4"
WW-FWS0040	5/8"	3"	120"	1-1/2"
WW-FWS0045	5/8"	4"	120"	2"
WW-FWS0050	5/8"	5"	120"	2-1/2"



DURAVAR®

Waste Water Treatment Wearshoes

Ultra-High Molecular Weight Polyethylene

Duravar® Carrying Wear Shoe

PRODUCT CODE	A (IN.)	B (IN.)	C (IN.)	D (IN.)	E (IN.)	F (IN.)
WW-CWS1001	5-1/2"	3"	1-5/16"	7/8"	3-3/4"	1/2"
WW-CWS1550	5-1/2"	3"	1-3/8"	7/8"	3-3/4"	1/2"
WW-CWS1600	6"	3"	1-3/8"	1-1/8"	3-3/4"	1/2"

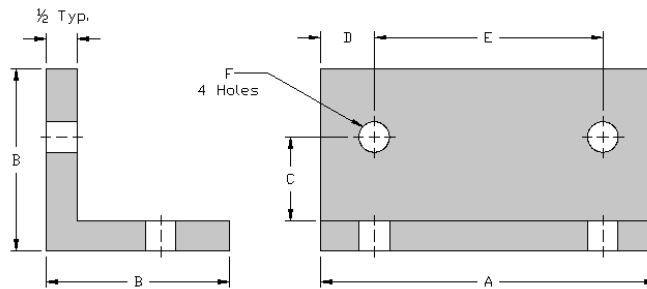

Duravar® "Single Hole" Return Wear Shoe

PRODUCT CODE	A (IN.)	B (IN.)	C (IN.)	D (IN.)	E (IN.)	F (IN.)
WW-RWS2001	4"	3-1/2"	1-5/16"	2"	3-3/4"	-
WW-RWS2450	4"	3-1/2"	1-3/8"	2"	3-3/4"	-
WW-CWS2550	4-1/2"	3-1/2"	1-3/8"	2-1/4"	3-3/4"	-

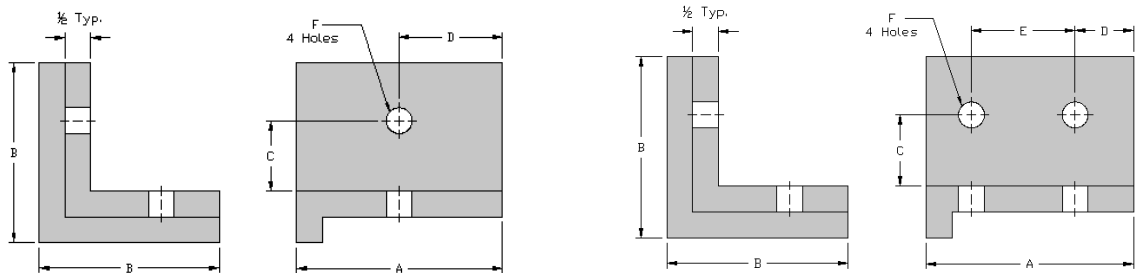

Duravar® "Double Hole" Return Wear Shoe

PRODUCT CODE	A (IN.)	B (IN.)	C (IN.)	D (IN.)	E (IN.)	F (IN.)
WW-RWS3400	4"	3-1/2"	1-3/8"	7/8"	2"	1/2"
WW-RWS3450	4-1/2"	3-1/2"	1-3/8"	7/8"	1"	1/2"
WW-RWS3600	6"	3-1/2"	1-3/8"	1-1/8"	3-3/4"	1/2"

OUR COMMITMENT TO YOU

Is to provide the finest quality materials in a timely fashion, and to stand behind our Duravar® products with knowledgeable customer service and technical support.

*Thank You for being a part of the
“Artek Team”*

Distributed by:



Call: 1 (866) 437-7427

Email: info@polymershapes.com

www.polymershapes.com



*Artek Has Been A Proud Member Of The
IAPD Since 1995*



Artek is continually adding new extruded UHMW-PE Profile shapes to our product line.
If the custom or standard profile you need does not appear here, please give our sales team a call.